



Equipment Supply Company



Instruction Manual

MAMMUT 100 Ton Jack

ESCO #91004



CAUTION:

THIS PRODUCT, AS WELL AS ALL TIRE TOOLS, SHOULD NEVER BE USED BY PERSONS UNLESS THEY HAVE BEEN TRAINED PROPERLY ACCORDING TO OSHA REGULATIONS 29CFR 1910.177 ENTITLED "SERVICING SINGLE-PIECE & MULTIPIECE RIM WHEELS".

FOR THE SAFE USE OF THIS PRODUCT, PLEASE READ INSTRUCTIONS. FAILURE TO DO SO CAN LEAD TO A VOID IN WARRANTY OR SERIOUS INJURY. PLEASE USE THIS TOOL AND OTHER TIRE SERVICE TOOLS WITH THE UPMOST SAFETY PRECAUTIONS.

CAUTION

Before using the product, carefully read the instructions manual and all stickers and warnings noted on the product. This is necessary to avoid injury to the operator and damage to the product.

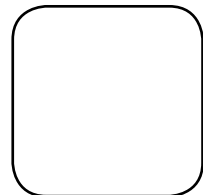
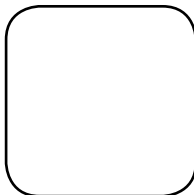
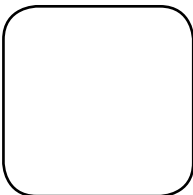

Product Description

The Mammut range of jacks offers service professionals a solution that is safe and easy to use, for all those operations to lift earthmoving, construction, quarry, and mining machinery, where maintenance requires professional skills and expertise. All models are air/hydraulic operated and equipped with a dual descent valve for greater control when bearing weight and automatic piston return; they can also be fitted with a manual emergency pump (on request).

Product Specifications

Tonnage: 100

Min. Height: 28.5" | 725 mm

Max. Height: 46.1" | 445 mm

Height: 68.7" | 1746 mm

Width: 24.4" | 619 mm

Length: 47.6" | 1210 mm

Weight: 715 lbs. | 324 kg

Working Air Pressure: 145-175 PSI



MAINTENANCE & INSPECTION:

- Visual inspection shall be made before and after each use. Checking for cracks, cracked welds and missing and/or damaged parts. Any jack that appears to be damaged in any way should be removed from service immediately.
- Because of the potential hazards associated with the misuse of equipment of this type, no modifications should be made of the product without consent from manufacturer. The manufacturer is **NOT** liable for any damages or injuries caused by an erroneous or incorrect use of the product.
- To ensure your jack a long life it is advisable to clean the pistons externally once daily.
- **Check the level of oil in the tank periodically:** this must be done with the pistons completely lowered. The oil level must be up to the small bolt that is on the rear side of the tank. If you have to top up the oil in the tank, make certain the oil you are using is compatible with what is already inside the tank so as not to compromise machine integrity. Any AW32 oil will suffice.
- If the oil level is higher than it should be, even by only a little, or if the jack has been turned upside down (which can happen during transport), the oil is expelled through the suction pump as mist. This disappears on its own when the oil level has been restored. If the oil inside the tank exceeds the level by a lot, it is advisable to remove some until it is back in the norm.

AIR BLEEDING:

Each time the jack is serviced, removing and refitting parts connected to the tank and motorpump, it is advisable to bleed off all air.

1. The piston must be moved out completely, without oil pressure.
2. Loosen (never unscrew completely) the dowel which is in the hole on the plate.
3. Manually, move the pistons downwards and let all the air out from the dowel, continuing until oil starts coming out and then close the dowel.
4. Move the piston back in completely and check the oil level.
5. Try to operate the jack without any load if the piston lowers in jerks repeat the procedure at least 2 or 3 times.

PRODUCT DETAILS:



- 1. Controls and Air Connection
- 2. Folding Handle
- 3. Lifting Cylinder
- 4. Wide Pneumatic Tires

DIMENSIONS:

- 1. Max. Height: 46.1" | 445 mm
- 2. Min. Height: 28.5" | 725 mm
- 3. Length: 47.6" | 1210 mm
- 4. Height: 68.7" | 1746 mm

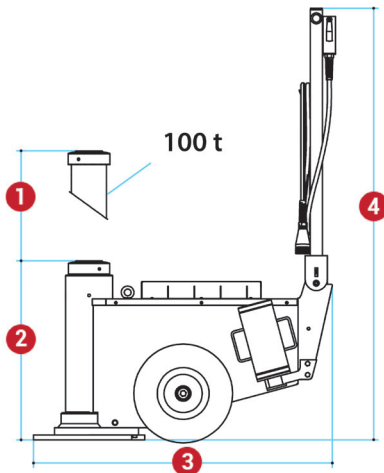

BEFORE USE AND SAFETY:

- Before use of this tool please verify that the application of this tool is compatible. For more information about this tool or any other tools from ESCO, Please call (800) 352-9852 or email info@esco.net.
- Only authorized personnel are allowed to use the equipment and they must know the contents of this operation and maintenance manual.
- The jack is an apparatus for **LIFTING ONLY** and **NOT** for supporting, it is absolutely forbidden to work in any way under the vehicle without support stands.
- Before starting to lift a vehicle, apply the parking brake.
- If the vehicle is loaded, check load stability when lifting.
- Place the jack so that the load is centered over it and where the gripping points are indicated by the vehicle manufacturer.
- During lifting and lowering, it is necessary to check there are no persons or objects under the suspended load or in the vicinity.
- Before lowering the load make certain the handle is in the horizontal position.
- Do **NOT** lift the load in a confined space so as not to run the risk of getting trapped.
- It is forbidden to use more than one jack simultaneously on the same load.
- Never tamper with the pressure relief valve that has the guarantee seal.

INSTRUCTION FOR OPERATION:

Connection to the compressed air system

- Compressed air enters into the jack circuit through the quick coupling; it is therefore necessary to have a connecting pipe with a quick coupling compatible with 1/2" GAS thread. Check the air supply pipe has a useful passage of at least 8 mm and it is not pinched or restricted anywhere.
- Never put the following into the compressed air circuit: hydraulic or Vaseline oil, brake liquid, kerosene or other liquids.

Using The Jack

- Expressly observe the safety rules described in this manual.
1. Position the jack under the gripping points as described in the manual of the vehicle manufacturer.
 2. The handle positioning lever (**A**) is on the left in relation to the worker; by moving it upwards the stopping system is released so the worker can then choose one of the four possible handle positions.
 3. Press the **GREEN** button on the remote control to lift the load.
 4. Press the **RED** button on the remote control to lower the load.
 5. After lifting the load, it is absolutely essential to rest it on the support stands before doing any work under it.



INSTRUCTION FOR OPERATION: *(cont'd)*

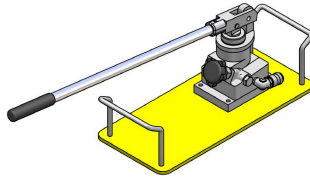

MANUAL PUMP

- The hand pump is necessary when compressed air is not available.

REMEMBER THAT THE JACK IS A LIFTING DEVICE AND NOT A SUPPORTING DEVICE

- The operator's employer will have to provide the necessary training and furnish the necessary information about the pumping and shifting forces.
- If the distributor breaks during use, work directly on the flow of air, closing the safety, between the quick coupling of the air inlet and the distributor itself.

BEFORE WORKING WITH THE JACK, LIFT WITH NO LOAD TO GET THE FEEL OF THE JACK.

IMPROPER USE

The air-hydraulic jack has been designed and made to lift vehicles. Any other use of the jack, such as for instance lifting a person or object is considered improper and unsafe.

AVAILABLE ACCESSORIES



#91029



#91030



#91031

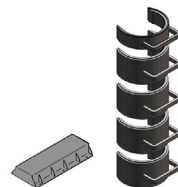

#91036



“Providing Quality Hydraulic Repair and Technical Support for All Your Hydraulic Product Needs”

GUARANTEED 1 Day Turnaround Service.

Received by ESCO - Repaired in 24 Hours - Returned to You!

- ▶ ESCO will pick up product for repair/warranty at your location.
- ▶ ESCO will guarantee Repair/Service for 30 days.
- ▶ ESCO has rental tools available
- ▶ ESCO repairs IMT, FEC, Stellar, Blackhawk, OTC, Power Team, Ame Int., & Enerpac hydraulic pumps, bead breaker, and cylinders.
- ▶ Authorized ESCO Repair & Warranty Centers Located through the US & Canada. For more information contact your ESCO sales representative.
- ▶ Technical Support Over the Phone Available by Calling 1-800-352-9852

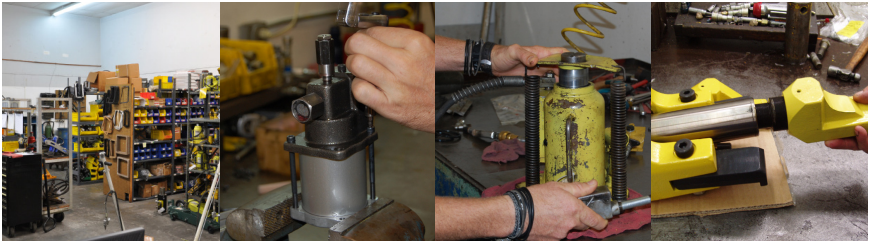

Prompt, reliable service after the sale is very important to ESCO. ESCO maintains an in-house repair facility in Brooksville, Florida. To insure that our customers have as little down-time as possible, we offer a 1 day turnaround service. Our factory repair service is equipped with all the tools and machinery needed to repair your equipment quickly and affordably. Our trained technicians are the best in the industry. Not only do we service our own products, but we also service our competitors' products.

In addition to ESCO's 30 years of providing quality repair service, ESCO has reached out and partnered with more than 50+ hydraulic repair facilities across the US & Canada, to deliver quality repair and timely return of products. Visit www.esco.net or call 1.800.352.9852 to hear more about the newly added "Authorized ESCO Warranty & Repair Facilities" across the US.

If you have a bead breaker, ram, or hydraulic pump that needs repair, ESCO fixes your product with factory parts and guarantees the repair. In addition to servicing ESCO brand products, we also repair CP, IMT, Elrick, Branick, Goodyear, FEC, Ame Int., and Haltec lines of hydraulic bead breakers, rams, pumps, jacks, and many other hydraulic tire service equipment.

The Proper Tools To Keep Your Equipment **MOVING**

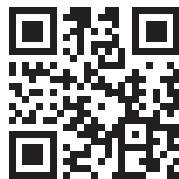

Scan this Code to Go to
the ESCO website

WWW.ESCO.NET



CONTACT INFO:

www.esco.net - info@esco.net

15270 Flight Path Drive

Brooksville, FL 34604

PH. 352.754.1117

Toll Free. 1.800.352.9852 (US, Canada Only)

Fax: 352.754.4508

ESCO - The Proper Tools to Keep Your Equipment Moving!

Stay Connected with ESCO...

