

300 Ton Heavyweight Jack

MODEL ESJ-300-27

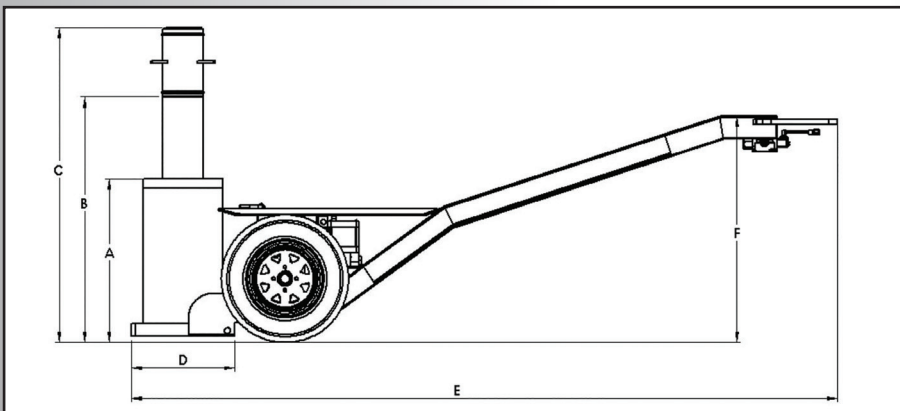
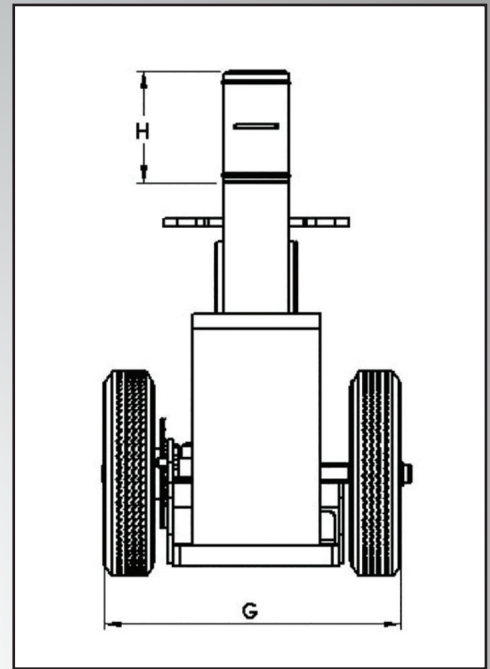

Capacity		300 Ton
Min. Height:	A	27" 69cm
Max. Height:	B	43" 109cm
Cylinder Base:	D	18" 46cm
Frame Length:	E	120" 305cm
Handle Height:	F	40" 102cm
Frame Width:	G	35" 89cm

Extension Height	Min. Height with Extension	Max. Height with Extension
(H)	(A+H)	(B + H = C)
6" 15cm	*33" 84cm	*49" 124cm
8" 20cm	*35" 89cm	*51" 130cm
10" 25cm	*37" 94cm	*53" 135cm
12" 30cm	*39" 99cm	*55" 140cm

*Extensions can be custom manufactured to any height

NOTE: ESCO reserves the right to change, alter, or modify product(s) without notice. This includes but is not limited to product: color, design, parts, accessories, etc.

sales@esco.net WWW.ESCO.NET 1.800.352.9852



COPYRIGHT 2017 • 15270 Flight Path Drive • Brooksville, FL 34604

